



CNC Video Measuring System

NEXIV

VMZ-K Series

Confocal Model



NEXIV VMZ-K Series

3D FOV Measurements Generated with Confocal Images

A ground-breaking multifunctional video measuring system developed on the strength of Nikon's leading optomechanics technology.

- Combines confocal optics and brightfield optics, for fast and accurate evaluation of fine three-dimensional geometries

- Allows both 2D and height measurements in the same field of view

This series can be optimally used for inspecting precise 3D-shaped samples, including micro bumps, circuit patterns, and bonding wires, as well as samples with countless points, such as probe cards.

The VMZ-K series can also measure both the shallow recesses and gentle ledges on PCBs.

Principle of Confocal Optics

Light passing through a pinhole on a spinning Nipkow disk is reflected by the workpiece at the focal point, back through the pinhole. This light is detected as a very narrow DOF confocal image by the camera. If there is no workpiece at the focal point, the light does not reflect back through the pinhole. By moving the focal plane in the vertical direction, the Confocal NEXIV VMZ-K series samples multiple confocal images and combines them to compose a confocal image with height information, provided by Nikon's unique interpolation technology.

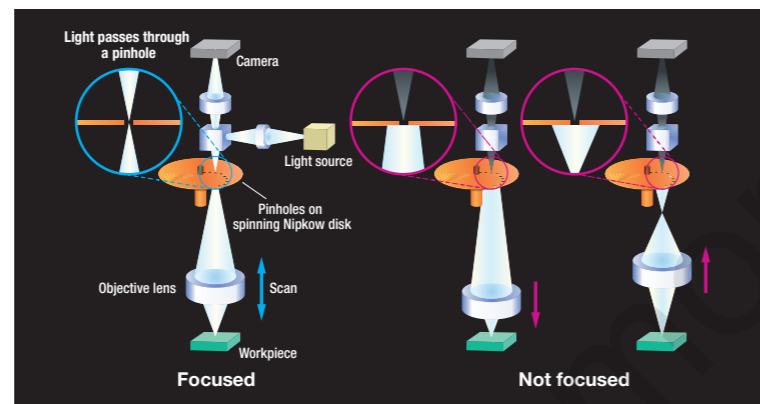

Nikon-Original Low Flare Confocal Optics

Brightfield Image (Bump)

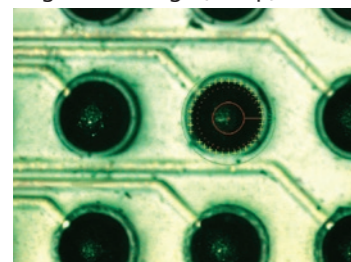

Confocal Image



Confocal images captured by Z scan are reconstructed in real time into 3D contour maps and EDF (Extended Depth of Focus) images.

Reconstructed images

3D Contour Image

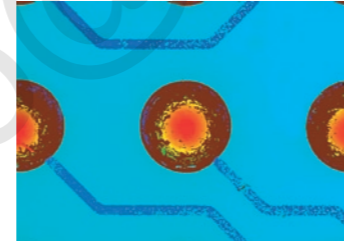

EDF Image

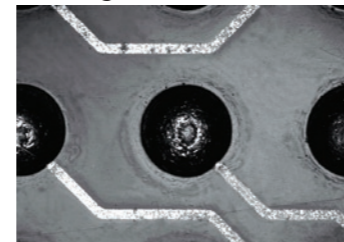

The VMZ-K series enables microscopic height measurements using various objective lenses, with two models to choose from, each featuring different stage strokes.

VMZ-K3040 Type-S/Type-H

Main Features

General model for a wide range of needs

Main Applications

- Microscopic bumps in advanced IC packages
- Probe cards
- Precision optical components
- Microscopic laser marks on semiconductor wafers
- MEMS
- Wire bonding



VMZ-K6555 Type-S/Type-H

Main Features

Handles printed circuit board sizes with its 650 x 550 mm stroke

Main Applications

- PCB with precise circuit patterns
- Probe cards
- LCD-related components



Objectives

Nikon offers five different objective types, enabling users to choose the optimal magnification model for the application.

		Type-S			Type-H		
Magnification		1.5x	3x	7.5x	15x	30x	
Working Distance		35 mm *1	24 mm	5 mm	20 mm	5 mm	
Field of View	Confocal	8 x 6 mm	4 x 3 mm	1.6 x 1.2 mm	0.8 x 0.6 mm	0.4 x 0.3 mm	
	Brightfield	8 x 6 to 0.53 x 0.4 mm	4 x 3 to 0.27 x 0.2 mm	1.6 x 1.2 to 0.11 x 0.08 mm	1.26 x 0.95 to 0.1 x 0.074 mm	0.63 x 0.47 to 0.05 x 0.04 mm	

*1: Ring illumination only has a traveling distance of 24 mm.

Field of View	W (mm) x L (mm)	8	4	2.0	1.6	1.26	1.00	0.8	0.63	0.53	0.4	0.27	0.20	0.11	0.100	0.05	Working distance
Type S	1.5 x	●	●	●	●	●	●	●	●	●	●	●	●	●	●	●	24 mm
	3 x	●	●	●	●	●	●	●	●	●	●	●	●	●	●	●	24 mm
	7.5 x	●	●	●	●	●	●	●	●	●	●	●	●	●	●	●	5 mm
Type H	15 x	●	●	●	●	●	●	●	●	●	●	●	●	●	●	●	20 mm
	30 x	●	●	●	●	●	●	●	●	●	●	●	●	●	●	●	5 mm

● Brightfield ● Confocal/Brightfield

High performing GUI and sophisticated software functionality provides the easiest and quickest 3D metrology

Teaching Generation/Replay

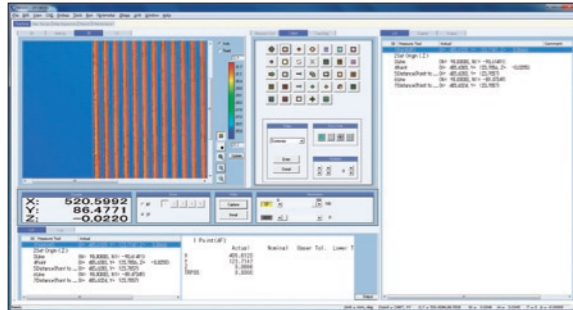

- Both 2D measurement of brightfield images and height measurement of 3D images are possible in the same field of view, at high speeds and with high accuracy.
- In addition to the measurement tools employed by the NEXIV series, 3D feature measurement tools are available for diverse workpiece shapes, such as ball/flat bumps, bonding wires, and probe card pins. The optimized algorithms for measurement sequence enable simultaneous measurement of multiple points in the field of view.
- Measurement results are stored as CSV format ASCII data for Data Reporting/SPC Analysis.

User-friendly operations enhance efficiency of semiconductor wafer and PCB chip measurements.

Map Recipe Generation

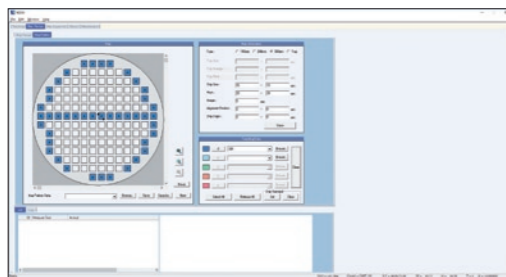

Wafer

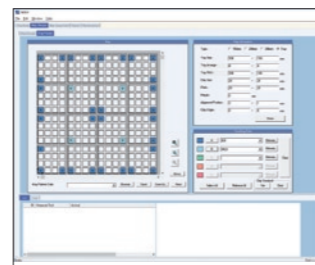

PCB Chip Map

- Any chip on the generated map can simply be measured by inputting chip size and pitch.
- Map generation can also be done on PCBs, composed of groups of chips.

Map Measurement Execution

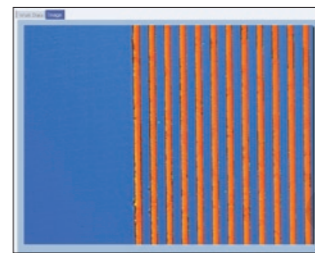
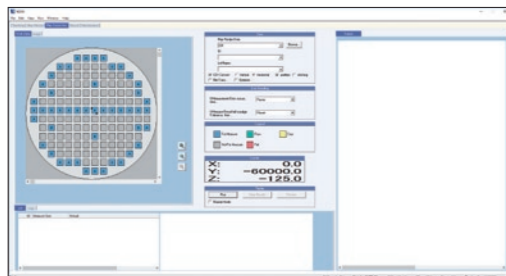
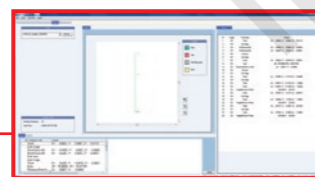
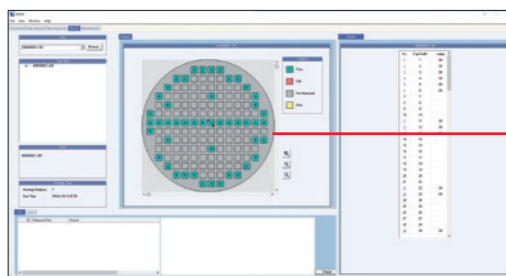

Image Tab

- A specified die can be easily measured by inputting map recipe file, ID, and lot number.
- The workpiece being measured can be viewed by changing to the image tab.

Measurement Result Review



Measurement Result

- The accept/reject status of every die can be graphically reviewed on the map.
- A result screen is shown when a die is selected, making it easy to verify each die's measurement results.

Probe Cards

Programming can be made from location data in one click. XYZ coordinates and coplanarity contact probe pins on probe cards be automatically measured with unique image processing tools.

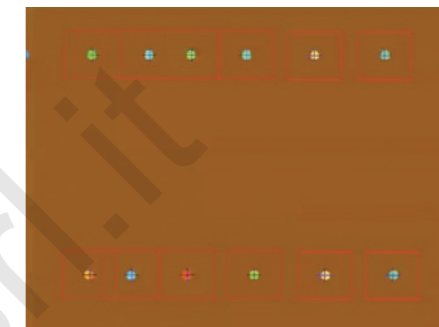

3D Image

Wafer Level Packages

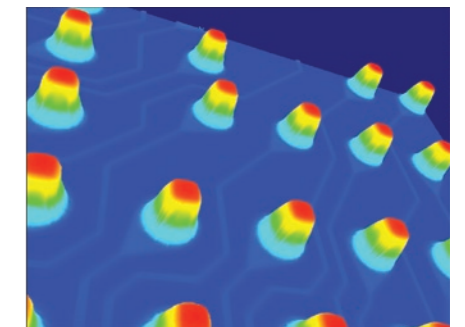

Bird's-eye View Image with 3D Viewer Software (option)

Fine Bump and Substrate Pattern

A combination of 2D measurement with 15x zoom brightfield image and 3D height measurement in the same field of view enables diverse measurements.

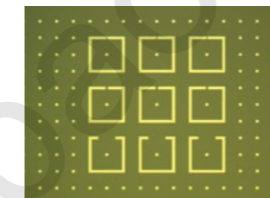

Brightfield Image (minimum magnification)



Brightfield Image (maximum magnification)

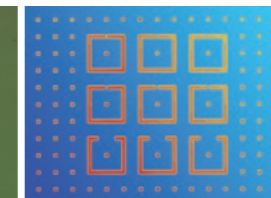

3D Image

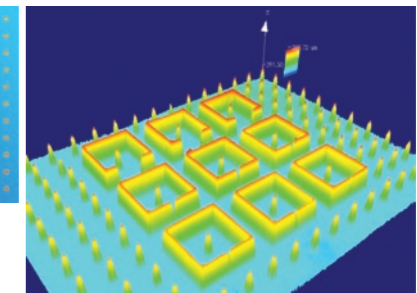

Bird's-eye View Image by 3D Viewer Software (option)

Bonding Wire Loop Height

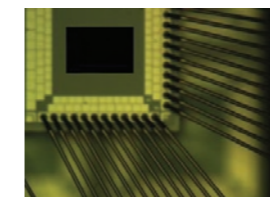

Brightfield Image

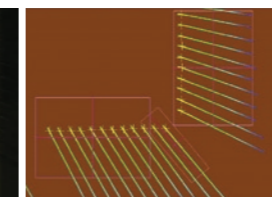

3D Image: simultaneous detection of the highest point of all wires

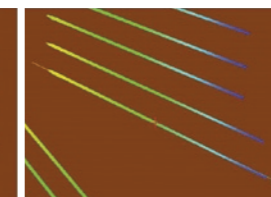

3D Image: display of wire height profile

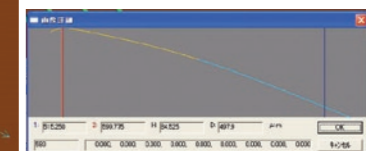

Precise PCB Pattern

Accurate measurement of high contrast samples tends to be difficult with brightfield illumination because their edges appear unclear. Confocal optics enables a clear display, and facilitates accurate detection of sample edges.

High Contrast Sample (copper wire on print board)

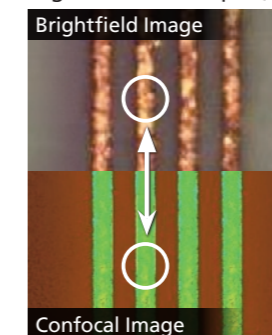

Brightfield Image

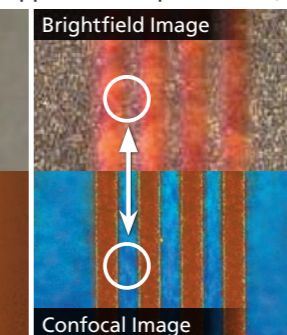

Confocal Image

Transparent sample (thin film)

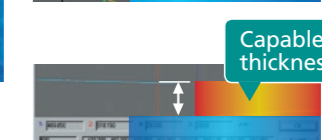
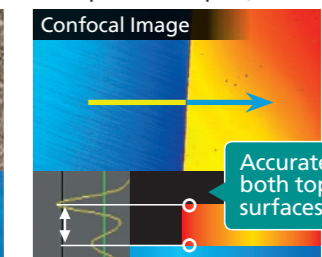

Accurately detect both top and bottom surfaces of thin film

Capable of measuring thickness of thin film

Image Archiving and Processing Software - EDF/Stitching Express

The EDF/Stitching Express software creates an image archiving library for confocal and brightfield images, and provides post-image processing functionalities, such as EDF and large-area image stitching.

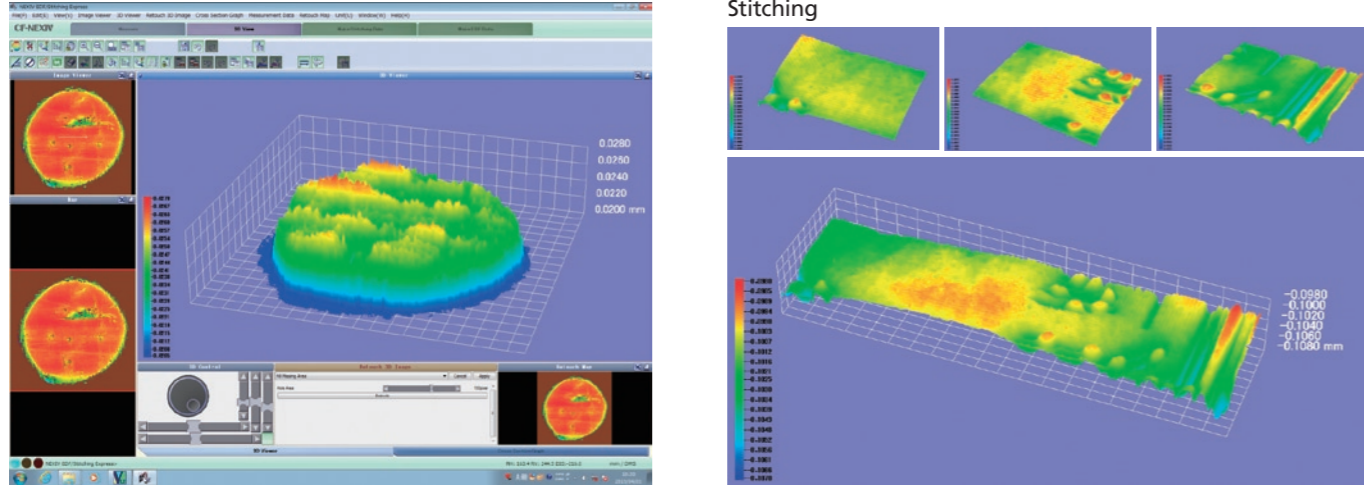

3D Surface Metrology Analysis Software - MountainsMap X

The MountainsMap X is a powerful software for surface metrology analysis. It provides the rich functionality of 3D visualization, cross-sectional view, 2D and 3D roughness, and other parameters based on the latest ISO standards.

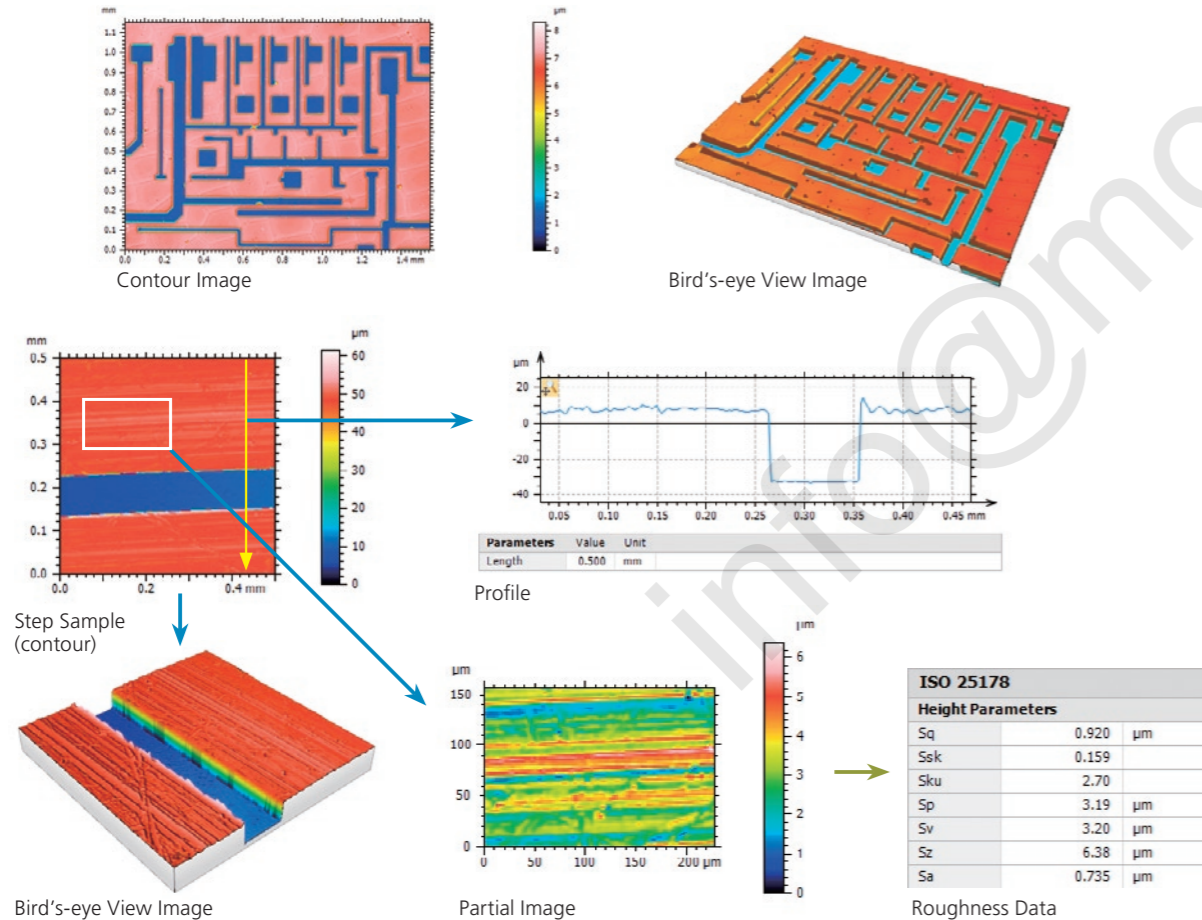

Wide FOV Optics (for high-magnification optical heads)

Wide field of view optics aids in the selection of the area to be measured and the creation of programs with high-magnification optical heads.

Compatible optical head	15x, 30x
Field of view	4.8 mm x 3.6 mm
Working distance	40.6 mm
Main optical head offset	64 mm
Illumination	Episcopic illumination only
Wide FOV optics effective ranges (mm)	VMZ-K3040: 236(X) x 400(Y) VMZ-K6555: 586(X) x 550(Y)

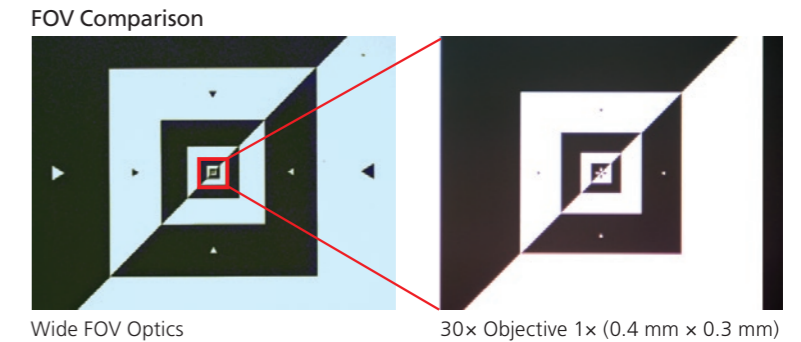
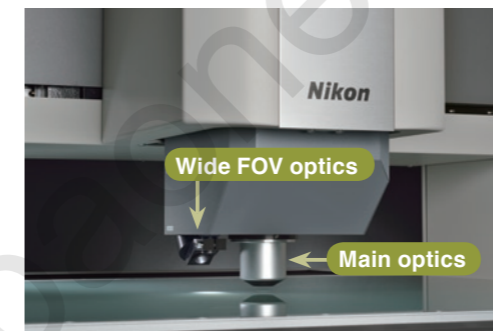
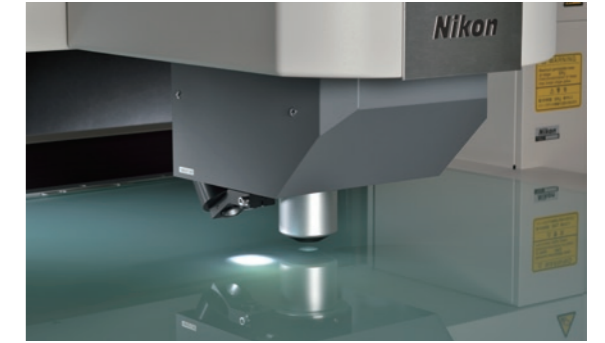

Dimensional Diagram

VMZ-K 3040

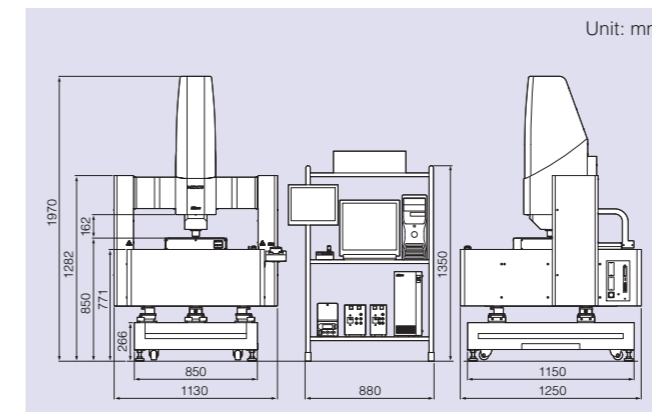

VMZ-K 6555

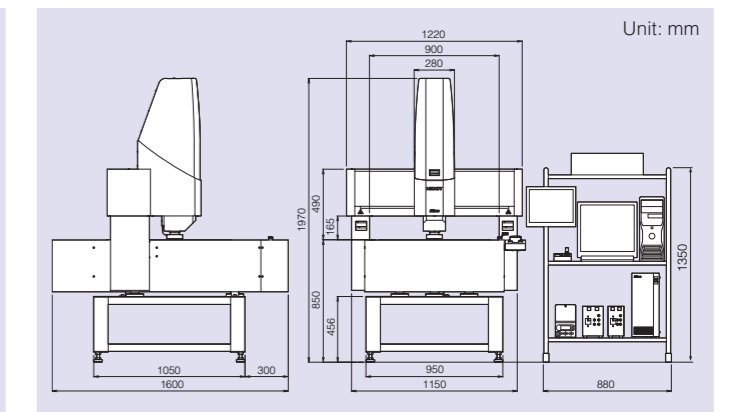

Specifications

Model	VMZ-K3040 Type-S					VMZ-K3040 Type-H					VMZ-K6555 Type-S					VMZ-K6555 Type-H					
	Standard head					High-magnification head					Standard head					High-magnification head					
Objectives																					
Magnification	1.5x	3x	7.5x	15x	30x	1.5x	3x	7.5x	15x	30x	1.5x	3x	7.5x	15x	30x	1.5x	3x	7.5x	15x	30x	
Working distance (*with ring illumination)	24 mm*	24 mm	5 mm	20 mm	5 mm	24 mm*	24 mm	5 mm	20 mm	5 mm	24 mm*	24 mm	5 mm	20 mm	5 mm	24 mm*	24 mm	5 mm	20 mm	5 mm	
Confocal Optics (Area height measurement)																					
Maximum scan height	1 mm																				
Field of view	8x6 mm	4x3 mm	1.6x1.2 mm	0.8x0.6 mm	0.4x0.3 mm	8x6 mm	4x3 mm	1.6x1.2 mm	0.8x0.6 mm	0.4x0.3 mm	8x6 mm	4x3 mm	1.6x1.2 mm	0.8x0.6 mm	0.4x0.3 mm	8x6 mm	4x3 mm	1.6x1.2 mm	0.8x0.6 mm	0.4x0.3 mm	
Height measurement repeatability (2σ)	0.6 μm	0.35 μm	0.25 μm	0.25 μm	0.2 μm	0.6 μm	0.35 μm	0.25 μm	0.25 μm	0.2 μm	0.6 μm	0.35 μm	0.25 μm	0.25 μm	0.2 μm	0.6 μm	0.35 μm	0.25 μm	0.25 μm	0.2 μm	
Height resolution	0.01 μm																				
Field of view	8x6 to 0.53x0.4 mm	4x3 to 0.27x0.2 mm	1.6x1.2 to 0.11x0.08 mm	1.26x0.95 to 0.1x0.074 mm	0.63x0.47 to 0.05x0.04 mm	8x6 to 0.53x0.4 mm	4x3 to 0.27x0.2 mm	1.6x1.2 to 0.11x0.08 mm	1.26x0.95 to 0.1x0.074 mm	0.63x0.47 to 0.05x0.04 mm	8x6 to 0.53x0.4 mm	4x3 to 0.27x0.2 mm	1.6x1.2 to 0.11x0.08 mm	1.26x0.95 to 0.1x0.074 mm	0.63x0.47 to 0.05x0.04 mm	8x6 to 0.53x0.4 mm	4x3 to 0.27x0.2 mm	1.6x1.2 to 0.11x0.08 mm	1.26x0.95 to 0.1x0.074 mm	0.63x0.47 to 0.05x0.04 mm	
Illumination	Diascopic, coaxial episcopic and ring					Diascopic and coaxial episcopic					Diascopic, coaxial episcopic and ring					Diascopic and coaxial episcopic					
Light source	White LED																				
Autofocus	Vision AF, Laser AF																				
Main Body																					
XYZ strokes	300 mm × 400 mm × 150 mm										650 mm × 550 mm × 150 mm										
Accuracy guaranteed loading capacity	20kg										30kg										
Maximum permissible error (L: Length in mm)	EUX, MPE: 1.5 + 4L/1000 μm EUY, MPE: 2.5 + 4L/1000 μm EUZ, MPE: 1 + L/1000 μm										EUX, MPE: 1.5 + 2.5L/1000 μm EUY, MPE: 2.5 + 2.5L/1000 μm EUZ, MPE: 1 + L/1000 μm										
Power source	AC 100 – 240 V ± 10% 50/60 Hz																				
Power consumption	10A – 5A																				
Operating conditions	Temperature: 20°C ± 0.5 K, Humidity: 70 % or less																				
Acquired standard	CE marking (low voltage/EMC/laser)																				
Dimensions and weight																					
Main body and table	1130 × 1250 × 1970 mm / approx. 800 kg										1220 × 1600 × 1970 mm approx. 800 kg										
Controller	190 × 450 × 440 mm / 20 kg																				
Installation area (WxD)	2500 × 1600 mm										2500 × 1900 mm										

*Please contact Nikon for permissible floor vibration specifications.

Specifications and equipment are subject to change without any notice or obligation on the part of the manufacturer. July 2021 ©2011-2021 NIKON CORPORATION

N.B. Export of the products* in this catalog is controlled under the Japanese Foreign Exchange and Foreign Trade Law. Appropriate export procedures shall be required in case of export from Japan.

*Products: Hardware and its technical information (including software)

Company names and product names appearing in this brochure are their registered trademarks or trademarks.

クラス1レーザー製品

CLASS 1 LASER PRODUCT



WARNING

TO ENSURE CORRECT USAGE, READ THE CORRESPONDING MANUALS CAREFULLY BEFORE USING THE EQUIPMENT.



NIKON CORPORATION

Shinagawa Intercity Tower C, 2-15-3, Konan, Minato-ku, Tokyo 108-6290, Japan

phone: +81-3-6433-3701 fax: +81-3-6433-3784

<https://www.nikon.com/products/industrial-metrology/>

ISO 14001 Certified
for NIKON CORPORATION

ISO 9001 Certified
for NIKON CORPORATION
Industrial Metrology Business Unit

NIKON METROLOGY EUROPE NV

Interleuvenlaan 86 B-3001 Leuven, Belgium

phone: +32-16-74-01-00 fax: +32-16-74-01-03

E-mail: Sales.Europe.NM@nikon.com

<http://www.nikonmetrology.com/en-gb>

NIKON METROLOGY UK LTD.

UNITED KINGDOM phone: +44-1332-811-349 fax: +44-1332-639-881

E-mail: Sales.UK.NM@nikon.com

NIKON METROLOGY SARL

FRANCE phone: +33-1-60-86-09-76 fax: +33-1-60-86-57-35

E-mail: Sales.France.NM@nikon.com

NIKON METROLOGY GMBH

GERMANY phone: +49-211-45-44-69-51

E-mail: Sales.Germany.NM@nikon.com

NIKON INSTRUMENTS S.p.A.

ITALY phone: +39-055-300-96-01 fax: +39-055-30-09-93

NIKON METROLOGY, INC.

12701 Grand River Road, Brighton, MI 48116 U.S.A.

phone: +1-810-220-4360 fax: +1-810-220-4300

E-mail: Sales.NM-US@nikon.com

<http://www.nikonmetrology.com/en-us>

NIKON METROLOGY - MÉXICO

MEXICO phone: +52-442-688-5067

E-mail: Sales.NM-MX@nikon.com

NIKON INSTRUMENTS (SHANGHAI) CO., LTD.

CHINA (Shanghai branch) phone: +86-21-6841-2050 fax: +86-21-6841-2060

(Beijing branch) phone: +86-10-5831-2028 fax: +86-10-5831-2026

(Guangzhou branch) phone: +86-20-3882-0551 fax: +86-20-3882-0580

NIKON INSTRUMENTS KOREA CO., LTD.

KOREA phone: +82-2-2186-8400 fax: +82-2-555-4415

NIKON SINGAPORE PTE. LTD.

SINGAPORE phone: +65-6559-3651 fax: +65-6559-3668

E-mail: NSG.Industrial-sales@nikon.com

PT. NIKON INDONESIA

INDONESIA phone: +62-267-864-3949 fax: +62-267-864-3950

E-mail: PTN.Instruments@nikon.com

NIKON SALES (THAILAND) CO., LTD.

THAILAND phone: +66-2633-5100 fax: 66-2633-5191