



Video Measuring System

NEXIV

VMZ-H3030

High-precision Model



NEXIV VMZ-H3030

Achieves measurement at the highest precision of the NEXIV series, as well as advanced usability and performance.

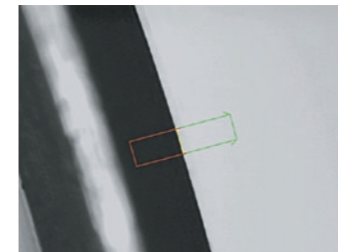

Finely machined part



Finely machined part



Molded part

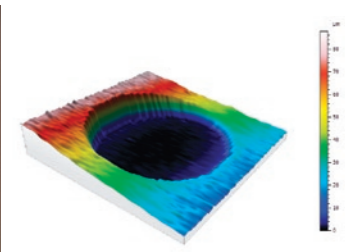

3D image by MountainsMap X
*optional software



Features

NEXIV model with the highest precision

EUX, MPE, EUY,MPE : **$0.6 + 2L / 1000$ um**

EUZ, MPE : **$0.9 + L / 150$ um**

XYZ Stroke: **$300 \times 300 \times 150$ mm**

Zooming heads

5 types of optical zoom systems

Type 1, 2, and 3 provide clear and low distortion image and high NA. Type 4 and TZ are designed to cover high magnification. 5 types are available to choose from to cover different fields of view and resolution requirements.

Zooming head	Optical magnification	Applications
Type 1	0.5X – 7.5X	Molds, mechanical parts (household, automobile), PCB, electronic parts, ceramic parts
Type 2	1X – 15X	
Type 3	2X – 30X	Electronic parts
Type 4	4X – 60X	High density package substrate (line width, height)
Type TZ	1X – 120X	Wafer pattern (WLP, bump height, rewiring mask, MEMS mask)

	0.5	1	2	4	7.5	8	15	16	30	32	60	64	120
Type 1	●	●	●	●	●								
Type 2		●	●	●	●	●	●						
Type 3			●	●	●	●	●	●	●				
Type 4				●	●	●	●	●	●	●	●		
Type TZ					●	●	●	●	●	●	●	●	●
Field of View	9.33 7.01	4.7 3.5	2.33 1.75	1.165 0.875	0.622 0.467	0.582 0.437	0.311 0.233	0.291 0.218	0.155 0.117	0.146 0.109	0.078 0.058	0.073 0.055	0.039 0.029

Illumination

8-segment ring illuminator with three incident angles

The three different angles allow the ring illuminator to accurately capture edges. All illuminators employ white LED and provide stability and long life.

*For Type4 and Type TZ, please refer to Specifications Chart of PG4

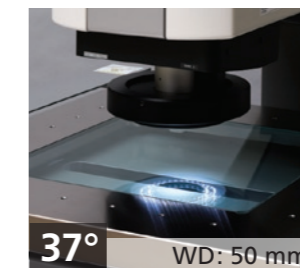

37° WD: 50 mm

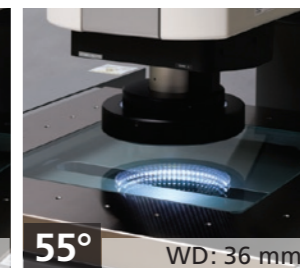

55° WD: 36 mm

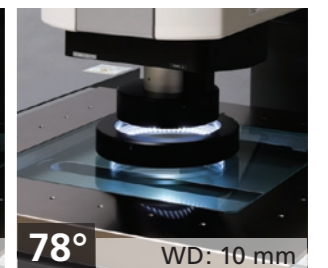

78° WD: 10 mm

Long WD

Short WD

Software

Easy to use, streamlined software

Provides enhanced ease of use with the customizable GUI and versatility based on Nikon's years of extensive experience in developing the NEXIV series.

[Functions possible with software]

■ Virtual (off-line) ... CAD interface off-line teaching support program

■ Profiler... CAD interface off-line teaching support program

■ MountainsMap X (optional)... Sample surfaces can be analyzed, based on ISO, with the data exported from the NEXIV system.

■ MapMeasure Pro (optional)... MapMeasure Pro creates wafer maps and is capable of automatically measuring any die on the wafer map. Tray maps can also be created.

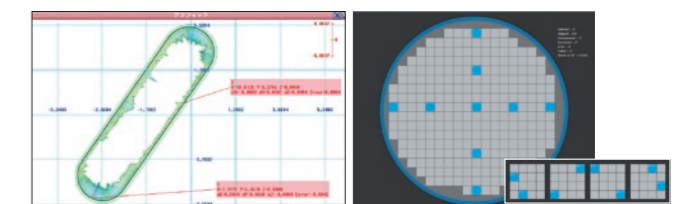
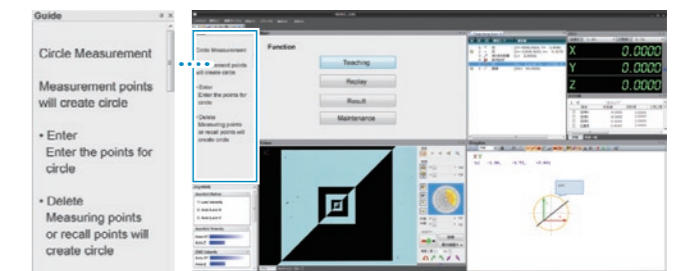

Profiler

MapMeasure Pro

Specifications

Model		VMZ-H3030
XYZ Strokes		300×300×150 mm
Minimum readout		0.01 μm
Maximum sample weight		30kg (Accuracy guaranteed: 10kg)
Maximum permissible error (for samples under 20 kg)		E _{UX} ,MPE E _{UY} ,MPE: 0.6+2L/1000 μm E _{UX} ,MPE: 0.9+3L/1000 μm E _{UZ} ,MPE: 0.9+L/150 μm
Accuracy guaranteed temperature		20 °C ± 0.5 K
Maximum driving speed XY, Z		100 mm/s , 50 mm/s
Minimum driving speed XY, Z		0.01 mm/s , 0.001 mm/s
Camera	VGA 1/3" B/W, Color *Color camera option is available only with Type 1, 2 and 3.	
Working distance	Type 1, 2, 3: 50 mm (10 mm when using 75 degree LED illumination) / Type 4: 30 mm Type TZ: 31 mm (low magnification), 11 mm (high magnification)	
Magnification and FOV	Type 1: 0.5~7.5×/9.33×7.01~0.622×0.467 mm Type 2: 1~15×/4.67×3.5~0.311×0.233 mm Type 3: 2~30×/2.33×1.75~0.155×0.117 mm Type 4: 4~60×/ 1.165×0.875~0.078×0.058 mm Type TZ: 1~120×/4.67×3.5~0.039×0.029 mm	
Autofocus	TTL Laser AF/Image AF	
illumination		
	Type 1, 2, 3, and 4	Episcopic, diascopic, and 8-segment ring with 3 angles *All white LED/Type 4 has only 1 angle
	Type TZ	Episcopic, diascopic, darkfield
Power source	AC 100 - 240 V ± 10% 50/60 Hz	
Power consumption	5 A - 2.5 A	
Dimensions & weight		
	Main body with table (W×D×H)	1000×1125×1750 mm / approx. 500 kg
	Controller	190×450×440 mm / approx. 20 kg
Footprint (W×D)	3000×2800 mm	

Dimensional diagram

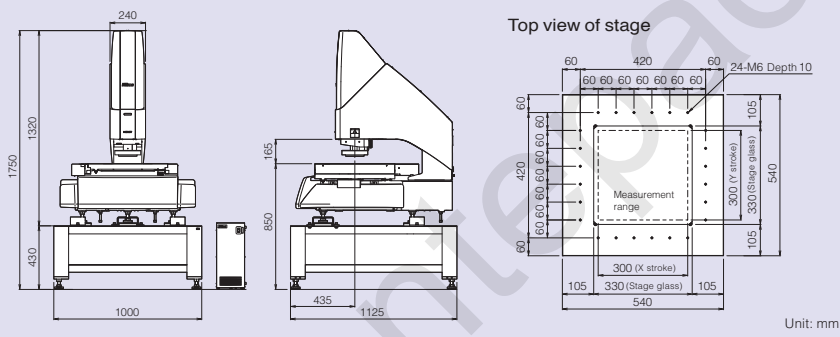

Specifications and equipment are subject to change without any notice or obligation on the part of the manufacturer. April 2023 ©2018-2023 NIKON CORPORATION
 N.B. Export of the products* in this catalog is controlled under the Japanese Foreign Exchange and Foreign Trade Law. Appropriate export procedures shall be required in case of export from Japan.
 *Products: Hardware and its technical information (including software)
 Company names and product names appearing in this brochure are their registered trademarks or trademarks.



WARNING TO ENSURE CORRECT USAGE, READ THE CORRESPONDING MANUALS CAREFULLY BEFORE USING THE EQUIPMENT.



NIKON CORPORATION
 Shinagawa Intercity Tower C, 2-15-3, Konan, Minato-ku, Tokyo 108-6290, Japan
 phone: +81-3-6433-3701 fax: +81-3-6433-3784
<https://industry.nikon.com/>

ISO 14001 Certified
 for NIKON CORPORATION

ISO 9001 Certified
 for NIKON CORPORATION
 Industrial Metrology Business Unit

NIKON METROLOGY EUROPE NV
 Interleuvenlaan 86 B-3001 Leuven, Belgium
 phone: +32-16-74-01-00 fax: +32-16-74-01-03
 E-mail: Sales.Europe.NM@nikon.com
<https://industry.nikon.com/en-gb/>

NIKON METROLOGY UK LTD.
 UNITED KINGDOM phone: +44-1332-811-349 fax: +44-1332-639-881
 E-mail: Sales.UK.NM@nikon.com

NIKON METROLOGY SARL
 FRANCE phone: +33-1-60-86-09-76 fax: +33-1-60-86-57-35
 E-mail: Sales.France.NM@nikon.com

NIKON METROLOGY GMBH
 GERMANY phone: +49-211-45-44-69-51
 E-mail: Sales.Germany.NM@nikon.com

NIKON INSTRUMENTS S.p.A.
 ITALY phone: +39-055-300-96-01 fax: +39-055-30-09-93

NIKON METROLOGY, INC.
 12701 Grand River Road, Brighton, MI 48116 U.S.A.
 phone: +1-810-220-4360 fax: +1-810-220-4300
 E-mail: Sales.NM-US@nikon.com
<https://industry.nikon.com/en-us/>

NIKON METROLOGY - MÉXICO
 MEXICO phone: +52-442-688-5067
 E-mail: Sales.NM-MX@nikon.com

NIKON PRECISION (SHANGHAI) CO., LTD.
 CHINA (Shanghai branch) phone: +86-21-6841-2050 fax: +86-21-6841-2060
 (Beijing branch) phone: +86-10-5831-2028 fax: +86-10-5831-2026
 (Guangzhou branch) phone: +86-20-3882-0551 fax: +86-20-3882-0580

NIKON INSTRUMENTS KOREA CO., LTD.
 KOREA phone: +82-2-6288-1900 fax: +82-2-555-4415

NIKON SINGAPORE PTE. LTD.
 SINGAPORE phone: +65-6559-3651 fax: +65-6559-3668
 E-mail: NSG.Industrial-sales@nikon.com

PT. NIKON INDONESIA
 INDONESIA phone: +62-267-864-3949 fax: +62-267-864-3950
 E-mail: PTN.Instruments@nikon.com
NIKON SALES (THAILAND) CO., LTD.
 THAILAND phone: +66-2633-5100 fax: 66-2633-5191